

Automatenverteiler
in Auf- und Unterputz!
Zubehörliste!



AUTOMATENVERTEILER

BAUTIEFE 120MM | 140MM | 210MM | 230MM

Prospekt 3.1

 **MADE
IN
GERMANY**

**Alphatec** GmbH
Schaltschranksysteme



Liebe Kundin, lieber Kunde,

willkommen bei Alphatec - Ihrem zuverlässigen Partner in Sachen Schaltschrankbau.

Seit 1993 fertigen wir in Bibersbach in der Nähe von Regensburg unsere eigenen Schaltschrankprodukte, welche über unsere Partner europaweit zum Einsatz kommen. Vom Kleinverteiler bis zur großen Hauptverteilung, vom Standardschrank bis hin zur komplett verdrahteten Sonderverteilung, wir garantieren Ihnen zu jeder Zeit höchste Qualität und besten Service. Und das alles zu 100% Made in Germany.

In diesem Prospekt stellen wir Ihnen unsere Automatenverteiler in den Bautiefen 120mm, 140mm, 210mm und 230mm vor. Des Weiteren finden Sie die passenden Montageplatten, Sammelschienensysteme, Feldabdeckungen, sowie das entsprechende Zubehör für Ihre Verteilungen.

Gerne beraten wir Sie zu unserem Produktprogramm oder entwickeln für Sie individuelle Sonderlösungen. Rufen Sie unser Alphatec-Team an - wir beraten Sie gerne!

Wir wünschen Ihnen viel Freude beim Planen und Bestellen!

Viele Grüße aus Bibersbach
Alphatec Schaltschranksysteme GmbH



Christa Schiegl
Geschäftsführerin



Erwin Schiegl
Geschäftsführer



4 Automatenverteiler BT120 I140mm

- 4 Höhe 500mm | Schutzklasse II
- 5 Höhe 650mm | Schutzklasse II
- 6 Höhe 800mm | Schutzklasse II
- 7 Höhe 950mm | Schutzklasse II
- 8 Höhe 1100mm | Schutzklasse II

9 Automatenverteiler BT210mm

- 9 Höhe 650mm | Schutzklasse I/II
- 10 Höhe 800mm | Schutzklasse I/II
- 11 Höhe 950mm | Schutzklasse I/II
- 12 Höhe 1100mm | Schutzklasse I/II
- 13 Höhe 1250mm | Schutzklasse I/II
- 14 Höhe 1400mm | Schutzklasse I/II

15 Automatenverteiler BT210 I 230mm

- 15 MP auf Rückwand | Höhe 800-1400mm

16 Automatenverteiler BT230mm

- 16 Höhe 650mm | Schutzklasse I/II
- 17 Höhe 800mm | Schutzklasse I/II
- 18 Höhe 950mm | Schutzklasse I/II
- 19 Höhe 1100mm | Schutzklasse I/II
- 20 Höhe 1250mm | Schutzklasse I/II
- 21 Höhe 1400mm | Schutzklasse I/II

23 Montageplatten

- 23 Montageplatte gelocht

24 Feldabdeckungen

- 24 PS | geschlossen / offen
- 25 PRL | offen für Sammelschienensysteme
- 26 PRL | geschlossen
- 27 PRL | offen

28 Sammelschienensysteme

- 28 5-polig
- 29 3-polig
- 30 1-polig

31 Zubehör

- 31 Zubehör Geräteträger
- 32 Zubehör Feldabdeckungen
- 33 Zubehör Sonstiges

35 Anhang

- 35 Notizen / Adresse

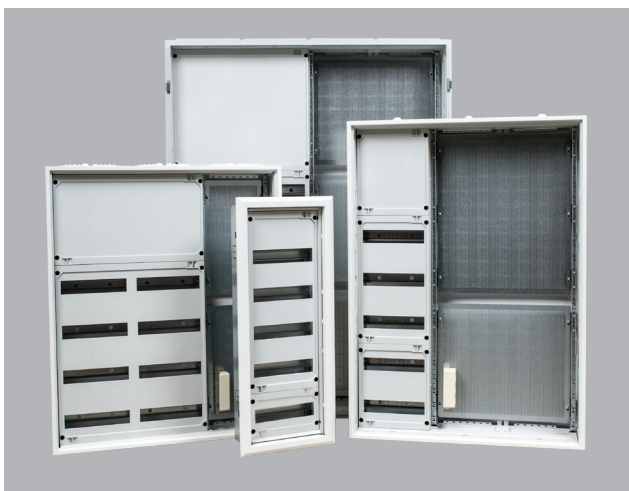

Automatenverteiler Bautiefe 120mm | 140mm

Höhe 500mm | Schutzklasse II

- für den Innenbereich
- Farbe: RAL 9016
- Schutzart: IP 30; Schutzklasse II (schutzisoliert)
- Bautiefe 140mm: Wandbefestigung Aufputz (**AVK**)
- Bautiefe 120mm: Wandbefestigung Unterputz (**UVK**)
- Einzeltür mit Drehverschluss, ab 3 Feldbreiten (800mm) Doppeltür
- Kabeleinführungen: BT 140mm: NF2w oben und unten
BT 120mm: NF3g oben und unten
- Geräteträger: für Reihenklemmen mit Feldabdeckung PS; Reihenabstand 150mm
- **S**-Schränke mit zusätzlichem einzelnen Geräteträger
- **M**-Schränke mit Montageplatte gelocht:
 - M1-3 = gesamte Breite der Montageplatte(n) 1-2 Feldbreiten











Auf Wunsch auch mit N-PE Schiene (**N**): Reihenabstand = 125mm, oben offene Abdeckung.

Bestellbeispiel: Artikelnummer + zusätzliches N: **AVK2-3-140-M1-N**

Komplettschränke

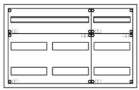
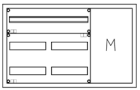
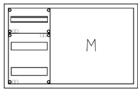
AD = Abdeckung
MP = Montageplatte
TE = Teilungseinheiten

Höhe 500mm		für Reihenklemmen	
<p>AVK 1-3-140 UVK 1-3-120</p>  <p>2x AD 24 TE</p> <p>300mm x 500mm</p>	<p>AVK 1-3-140-M1 UVK 1-3-120-M1</p>  <p>1x MP</p> <p>300mm x 500mm</p>	<p>AVK 2-3-140 UVK 2-3-120</p>  <p>2x AD 48 TE</p> <p>550mm x 500mm</p>	<p>AVK 2-3-140-S UVK 2-3-120-S</p>  <p>4x AD 48 TE</p> <p>550mm x 500mm</p>
<p>AVK 2-3-140-M1 UVK 2-3-120-M1</p>  <p>2x AD 1x MP 24 TE</p> <p>550mm x 500mm</p>	<p>AVK 2-3-140-M2 UVK 2-3-120-M2</p>  <p>1x MP</p> <p>550mm x 500mm</p>	<p>AVK 3-3-140-S UVK 3-3-120-S</p>  <p>4x AD 72 TE</p> <p>800mm x 500mm</p>	<p>AVK 3-3-140-M1 UVK 3-3-120-M1</p>  <p>2x AD 1x MP 48 TE</p> <p>800mm x 500mm</p>
<p>AVK 3-3-140-M2 UVK 3-3-120-M2</p>  <p>2x AD 1x MP 24 TE</p> <p>800mm x 500mm</p>	<p>AVK 3-3-140-M3 UVK 3-3-120-M3</p>  <p>2x MP</p> <p>800mm x 500mm</p>		

Automatenverteiler Bautiefe 120mm | 140mm







Höhe 650mm | Schutzklasse II

Komplettschränke

AD = Abdeckung
MP = Montageplatte
TE = Teilungseinheiten

Höhe 650mm

für Reihenklammern

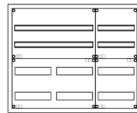
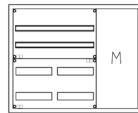
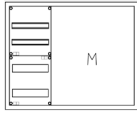
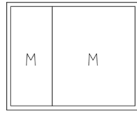
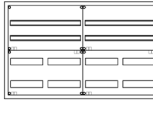
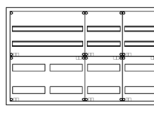
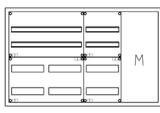
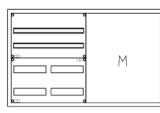
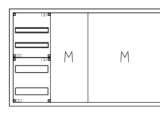
<p>AVK 1-4-140 UVK 1-4-120</p>  <p>2x AD 24 TE</p> <p>300mm x 650mm</p>	<p>AVK 1-4-140-M1 UVK 1-4-120-M1</p>  <p>1x MP</p> <p>300mm x 650mm</p>	<p>AVK 2-4-140 UVK 2-4-120</p>  <p>2x AD 48 TE</p> <p>550mm x 650mm</p>	<p>AVK 2-4-140-S UVK 2-4-120-S</p>  <p>4x AD 48 TE</p> <p>550mm x 650mm</p>
<p>AVK 2-4-140-M1 UVK 2-4-120-M1</p>  <p>2x AD 1x MP 24 TE</p> <p>550mm x 650mm</p>	<p>AVK 2-4-140-M2 UVK 2-4-120-M2</p>  <p>1x MP</p> <p>550mm x 650mm</p>	<p>AVK 3-4-140-S UVK 3-4-120-S</p>  <p>4x AD 72 TE</p> <p>800mm x 650mm</p>	<p>AVK 3-4-140-M1 UVK 3-4-120-M1</p>  <p>2x AD 1x MP 48 TE</p> <p>800mm x 650mm</p>
<p>AVK 3-4-140-M2 UVK 3-4-120-M2</p>  <p>2x AD 1x MP 24 TE</p> <p>800mm x 650mm</p>	<p>AVK 3-4-140-M3 UVK 3-4-120-M3</p>  <p>2x MP</p> <p>800mm x 650mm</p>	<p>AVK 4-4-140 UVK 4-4-120</p>  <p>4x AD 96 TE</p> <p>1050mm x 650mm</p>	<p>AVK 4-4-140-S UVK 4-4-120-S</p>  <p>6x AD 96 TE</p> <p>1050mm x 650mm</p>
<p>AVK 4-4-140-M1 UVK 4-4-120-M1</p>  <p>4x AD 1x MP 72 TE</p> <p>1050mm x 650mm</p>	<p>AVK 4-4-140-M2 UVK 4-4-120-M2</p>  <p>2x AD 1x MP 48 TE</p> <p>1050mm x 650mm</p>	<p>AVK 4-4-140-M3 UVK 4-4-120-M3</p>  <p>2x AD 2x MP 24 TE</p> <p>1050mm x 650mm</p>	

Automatenverteiler Bautiefe 120mm I 140mm









Höhe 800mm I Schutzklasse II

Komplettschränke

AD = Abdeckung
MP = Montageplatte
TE = Teilungseinheiten

Höhe 800mm

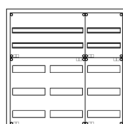
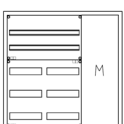
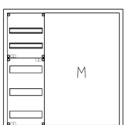
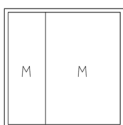
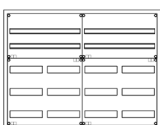
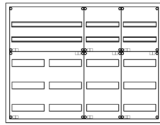
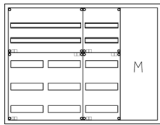
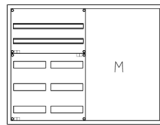
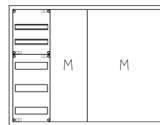
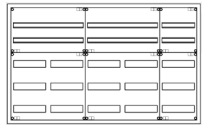
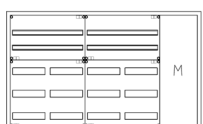
für Reihenklemmen

<p>AVK 1-5-140 UVK 1-5-120</p>  <p>2x AD 36 TE</p> <p>300mm x 800mm</p>	<p>AVK 1-5-140-M1 UVK 1-5-120-M1</p>  <p>1x MP</p> <p>300mm x 800mm</p>	<p>AVK 2-5-140 UVK 2-5-120</p>  <p>2x AD 72 TE</p> <p>550mm x 800mm</p>	<p>AVK 2-5-140-S UVK 2-5-120-S</p>  <p>4x AD 72 TE</p> <p>550mm x 800mm</p>
<p>AVK 2-5-140-M1 UVK 2-5-120-M1</p>  <p>2x AD 1x MP 36 TE</p> <p>550mm x 800mm</p>	<p>AVK 2-5-140-M2 UVK 2-5-120-M2</p>  <p>1x MP</p> <p>550mm x 800mm</p>	<p>AVK 3-5-140-S UVK 3-5-120-S</p>  <p>4x AD 108 TE</p> <p>800mm x 800mm</p>	<p>AVK 3-5-140-M1 UVK 3-5-120-M1</p>  <p>2x AD 1x MP 72 TE</p> <p>800mm x 800mm</p>
<p>AVK 3-5-140-M2 UVK 3-5-120-M2</p>  <p>2x AD 1x MP 36 TE</p> <p>800mm x 800mm</p>	<p>AVK 3-5-140-M3 UVK 3-5-120-M3</p>  <p>2x MP</p> <p>800mm x 800mm</p>	<p>AVK 4-5-140 UVK 4-5-120</p>  <p>4x AD 144 TE</p> <p>1050mm x 800mm</p>	<p>AVK 4-5-140-S UVK 4-5-120-S</p>  <p>6x AD 144 TE</p> <p>1050mm x 800mm</p>
<p>AVK 4-5-140-M1 UVK 4-5-120-M1</p>  <p>4x AD 1x MP 108 TE</p> <p>1050mm x 800mm</p>	<p>AVK 4-5-140-M2 UVK 4-5-120-M2</p>  <p>2x AD 1x MP 72 TE</p> <p>1050mm x 800mm</p>	<p>AVK 4-5-140-M3 UVK 4-5-120-M3</p>  <p>2x AD 2x MP 36 TE</p> <p>1050mm x 800mm</p>	<p>AVK 5-5-140-S UVK 5-5-120-S</p>  <p>6x AD 180 TE</p> <p>1300mm x 800mm</p>
<p>AVK 5-5-140-M1 UVK 5-5-120-M1</p>  <p>4x AD 1x MP 144 TE</p> <p>1300mm x 800mm</p>	<p>AVK 5-5-140-M2 UVK 5-5-120-M2</p>  <p>4x AD 1x MP 108 TE</p> <p>1300mm x 800mm</p>	<p>AVK 5-5-140-M3 UVK 5-5-120-M3</p>  <p>2x AD 2x MP 72 TE</p> <p>1300mm x 800mm</p>	

Automatenverteiler Bautiefe 120mm | 140mm











Höhe 950mm | Schutzklasse II

Komplettschränke

AD = Abdeckung
MP = Montageplatte
TE = Teilungseinheiten

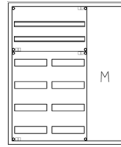
Höhe 950mm

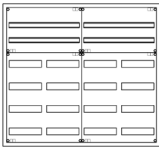
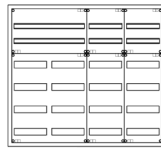
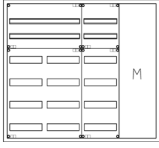
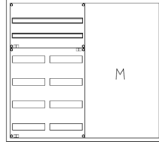
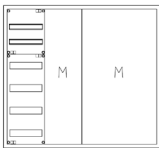
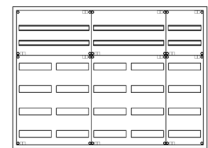
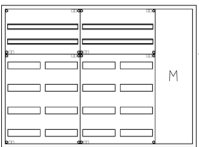
für Reihenklammern

<p>AVK 1-6-140 UVK 1-6-120</p>  <p>2x AD 48 TE</p> <p>300mm x 950mm</p>	<p>AVK 1-6-140-M1 UVK 1-6-120-M1</p>  <p>1x MP</p> <p>300mm x 950mm</p>	<p>AVK 2-6-140 UVK 2-6-120</p>  <p>2x AD 96 TE</p> <p>550mm x 950mm</p>	<p>AVK 2-6-140-S UVK 2-6-120-S</p>  <p>4x AD 96 TE</p> <p>550mm x 950mm</p>
<p>AVK 2-6-140-M1 UVK 2-6-120-M1</p>  <p>2x AD 1x MP 48 TE</p> <p>550mm x 950mm</p>	<p>AVK 2-6-140-M2 UVK 2-6-120-M2</p>  <p>1x MP</p> <p>550mm x 950mm</p>	<p>AVK 3-6-140-S UVK 3-6-120-S</p>  <p>4x AD 144 TE</p> <p>800mm x 950mm</p>	<p>AVK 3-6-140-M1 UVK 3-6-120-M1</p>  <p>2x AD 1x MP 96 TE</p> <p>800mm x 950mm</p>
<p>AVK 3-6-140-M2 UVK 3-6-120-M2</p>  <p>2x AD 1x MP 48 TE</p> <p>800mm x 950mm</p>	<p>AVK 3-6-140-M3 UVK 3-6-120-M3</p>  <p>2x MP</p> <p>800mm x 950mm</p>	<p>AVK 4-6-140 UVK 4-6-120</p>  <p>4x AD 192 TE</p> <p>1050mm x 950mm</p>	<p>AVK 4-6-140-S UVK 4-6-120-S</p>  <p>6x AD 192 TE</p> <p>1050mm x 950mm</p>
<p>AVK 4-6-140-M1 UVK 4-6-120-M1</p>  <p>4x AD 1x MP 144 TE</p> <p>1050mm x 950mm</p>	<p>AVK 4-6-140-M2 UVK 4-6-120-M2</p>  <p>2x AD 1x MP 96 TE</p> <p>1050mm x 950mm</p>	<p>AVK 4-6-140-M3 UVK 4-6-120-M3</p>  <p>2x AD 2x MP 48 TE</p> <p>1050mm x 950mm</p>	<p>AVK 5-6-140-S UVK 5-6-120-S</p>  <p>6x AD 240 TE</p> <p>1300mm x 950mm</p>
<p>AVK 5-6-140-M1 UVK 5-6-120-M1</p>  <p>4x AD 1x MP 192 TE</p> <p>1300mm x 950mm</p>	<p>AVK 5-6-140-M2 UVK 5-6-120-M2</p>  <p>4x AD 1x MP 144 TE</p> <p>1300mm x 950mm</p>	<p>AVK 5-6-140-M3 UVK 5-6-120-M3</p>  <p>2x AD 2x MP 96 TE</p> <p>1300mm x 950mm</p>	

Automatenverteiler Bautiefe 120mm I 140mm















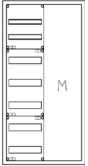

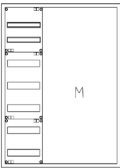

Höhe 1100mm I Schutzklasse II

Komplettschränke

AD = Abdeckung
MP = Montageplatte
TE = Teilungseinheiten

Höhe 1100mm

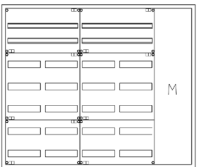
für Reihenklemmen

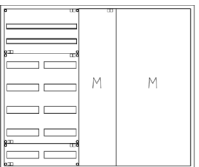
<p>AVK 1-7-140 UVK 1-7-120</p>  <p>3x AD 60 TE</p> <p>300mm x 1100mm</p>	<p>AVK 1-7-140-M1 UVK 1-7-120-M1</p>  <p>1x MP</p> <p>300mm x 1100mm</p>	<p>AVK 2-7-140 UVK 2-7-120</p>  <p>3x AD 120 TE</p> <p>550mm x 1100mm</p>	<p>AVK 2-7-140-S UVK 2-7-120-S</p>  <p>6x AD 120 TE</p> <p>550mm x 1100mm</p>
<p>AVK 2-7-140-M1 UVK 2-7-120-M1</p>  <p>3x AD 1x MP 60 TE</p> <p>550mm x 1100mm</p>	<p>AVK 2-7-140-M2 UVK 2-7-120-M2</p>  <p>1x MP</p> <p>550mm x 1100mm</p>	<p>AVK 3-7-140-S UVK 3-7-120-S</p>  <p>6x AD 180 TE</p> <p>800mm x 1100mm</p>	<p>AVK 3-7-140-M1 UVK 3-7-120-M1</p>  <p>3x AD 1x MP 120 TE</p> <p>800mm x 1100mm</p>
<p>AVK 3-7-140-M2 UVK 3-7-120-M2</p>  <p>3x AD 1x MP 60 TE</p> <p>800mm x 1100mm</p>	<p>AVK 3-7-140-M3 UVK 3-7-120-M3</p>  <p>2x MP</p> <p>800mm x 1100mm</p>	<p>AVK 4-7-140 UVK 4-7-120</p>  <p>6x AD 240 TE</p> <p>1050mm x 1100mm</p>	<p>AVK 4-7-140-S UVK 4-7-120-S</p>  <p>9x AD 240 TE</p> <p>1050mm x 1100mm</p>
<p>AVK 4-7-140-M1 UVK 4-7-120-M1</p>  <p>6x AD 1x MP 180 TE</p> <p>1050mm x 1100mm</p>	<p>AVK 4-7-140-M2 UVK 4-7-120-M2</p>  <p>3x AD 1x MP 120 TE</p> <p>1050mm x 1100mm</p>	<p>AVK 4-7-140-M3 UVK 4-7-120-M3</p>  <p>3x AD 2x MP 60 TE</p> <p>1050mm x 1100mm</p>	<p>AVK 5-7-140-S UVK 5-7-120-S</p>  <p>9x AD 300 TE</p> <p>1300mm x 1100mm</p>
<p>AVK 5-7-140-M1 UVK 5-7-120-M1</p>  <p>6x AD 1x MP 240 TE</p> <p>1300mm x 1100mm</p>	<p>AVK 5-7-140-M2 UVK 5-7-120-M2</p>  <p>6x AD 1x MP 180 TE</p> <p>1300mm x 1100mm</p>	<p>AVK 5-7-140-M3 UVK 5-7-120-M3</p>  <p>3x AD 2x MP 120 TE</p> <p>1300mm x 1100mm</p>	

Automatenverteiler Bautiefe 210mm

Höhe 650mm | Schutzklasse I/II

- für den Innenbereich
- Farbe: RAL 9016
- Schutzart: IP 41
- **AVB/UVB**: Schutzklasse I (geerdet)
- **AVK/UVK**: Schutzklasse II (schutzisoliert)
- Wandbefestigung Aufputz (**AVB/AVK**)
- Wandbefestigung Unterputz (**UVB/UVK**)
- Einzeltür mit Drehverschluss, ab 3 Feldbreiten (800mm) Doppeltür
- Kabeleinführungen: NF1w (oben) und NF2w (unten)
- Geräteträger: für Reihenklemmen mit Feldabdeckung PRL; Reihenabstand 150mm
- **S**-Schränke mit zusätzlichem einzelnen Geräteträger
- **M**-Schränke mit Montageplatte gelocht:
 - M1-2 = gesamte Breite der Montageplatte(n) 1-2 Feldbreiten











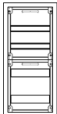

Auf Wunsch auch mit PS Abdeckungen (**P**): Bestellbeispiel: Artikelnummer + zusätzliches P: **AVK2-4-210-M1-P**
Allgemeines Bestellbeispiel entweder **B** oder **K** Schrank: **AVK 2-5-210**

Komplettschränke

AD = Abdeckung
MP = Montageplatte
TE = Teilungseinheiten

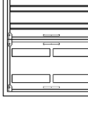
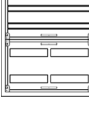
Höhe 650mm

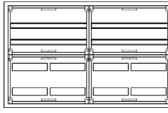
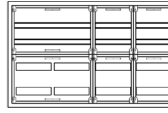
für Reihenklemmen

<p>AVB/K 1-4-210 UVB/K 1-4-210</p>  <p>2x AD 24 TE</p> <p>300mm x 650mm</p>	<p>AVB/K 1-4-210-M1 UVB/K 1-4-210-M1</p>  <p>1x MP</p> <p>300mm x 650mm</p>	<p>AVB/K 2-4-210 UVB/K 2-4-210</p>  <p>2x AD 48 TE</p> <p>550mm x 650mm</p>	<p>AVB/K 2-4-210-S UVB/K 2-4-210-S</p>  <p>4x AD 48 TE</p> <p>550mm x 650mm</p>
<p>AVB/K 2-4-210-M1 UVB/K 2-4-210-M1</p>  <p>2x AD 1x MP 24 TE</p> <p>550mm x 650mm</p>	<p>AVB/K 2-4-210-M2 UVB/K 2-4-210-M2</p>  <p>1x MP</p> <p>550mm x 650mm</p>	<p>AVB/K 3-4-210-S UVB/K 3-4-210-S</p>  <p>4x AD 72 TE</p> <p>800mm x 650mm</p>	<p>AVB/K 3-4-210-M1 UVB/K 3-4-210-M1</p>  <p>2x AD 1x MP 48 TE</p> <p>800mm x 650mm</p>
<p>AVB/K 3-4-210-M2 UVB/K 3-4-210-M2</p>  <p>2x AD 1x MP 24 TE</p> <p>800mm x 650mm</p>	<p>AVB/K 4-4-210 UVB/K 4-4-210</p>  <p>4x AD 96 TE</p> <p>1050mm x 650mm</p>	<p>AVB/K 4-4-210-S UVB/K 4-4-210-S</p>  <p>6x AD 96 TE</p> <p>1050mm x 650mm</p>	<p>AVB/K 4-4-210-M1 UVB/K 4-4-210-M1</p>  <p>4x AD 1x MP 72 TE</p> <p>1050mm x 650mm</p>

Automatenverteiler Bautiefe 210mm













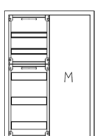

Höhe 650mm | 800mm | Schutzklasse I/II

Komplettsschränke

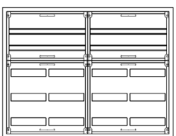
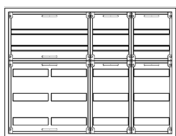
AD = Abdeckung
MP = Montageplatte
TE = Teilungseinheiten

Höhe 650mm | 800mm

für Reihenklammern

<p>AVB/K 4-4-210-M2 UVB/K 4-4-210-M2</p>  <p>4x AD 1x MP 48 TE</p> <p>1050mm x 650mm</p>			
<p>AVB/K 1-5-210 UVB/K 1-5-210</p>  <p>2x AD 36 TE</p> <p>300mm x 800mm</p>	<p>AVB/K 1-5-210-M1 UVB/K 1-5-210-M1</p>  <p>1x MP</p> <p>300mm x 800mm</p>	<p>AVB/K 2-5-210 UVB/K 2-5-210</p>  <p>2x AD 72 TE</p> <p>550mm x 800mm</p>	<p>AVB/K 2-5-210-S UVB/K 2-5-210-S</p>  <p>4x AD 72 TE</p> <p>550mm x 800mm</p>
<p>AVB/K 2-5-210-M1 UVB/K 2-5-210-M1</p>  <p>2x AD 1x MP 36 TE</p> <p>550mm x 800mm</p>	<p>AVB/K 2-5-210-M2 UVB/K 2-5-210-M2</p>  <p>1x MP</p> <p>550mm x 800mm</p>	<p>AVB/K 3-5-210-S UVB/K 3-5-210-S</p>  <p>4x AD 108 TE</p> <p>800mm x 800mm</p>	<p>AVB/K 3-5-210-M1 UVB/K 3-5-210-M1</p>  <p>2x AD 1x MP 72 TE</p> <p>800mm x 800mm</p>
<p>AVB/K 3-5-210-M2 UVB/K 3-5-210-M2</p>  <p>2x AD 1x MP 36 TE</p> <p>800mm x 800mm</p>	<p>AVB/K 4-5-210 UVB/K 4-5-210</p>  <p>4x AD 144 TE</p> <p>1050mm x 800mm</p>	<p>AVB/K 4-5-210-S UVB/K 4-5-210-S</p>  <p>6x AD 144 TE</p> <p>1050mm x 800mm</p>	<p>AVB/K 4-5-210-M1 UVB/K 4-5-210-M1</p>  <p>4x AD 1x MP 108 TE</p> <p>1050mm x 800mm</p>
<p>AVB/K 4-5-210-M2 UVB/K 4-5-210-M2</p>  <p>2x AD 1x MP 72 TE</p> <p>1050mm x 800mm</p>	<p>AVB/K 5-5-210-S UVB/K 5-5-210-S</p>  <p>6x AD 108 TE</p> <p>1300mm x 800mm</p>	<p>AVB/K 5-5-210-M1 UVB/K 5-5-210-M1</p>  <p>4x AD 1x MP 144 TE</p> <p>1300mm x 800mm</p>	<p>AVB/K 5-5-210-M2 UVB/K 5-5-210-M2</p>  <p>4x AD 1x MP 108 TE</p> <p>1300mm x 800mm</p>

Automatenverteiler Bautiefe 210mm











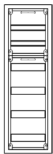

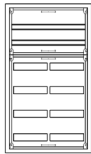
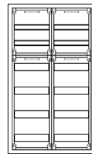
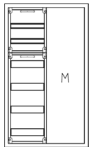
Höhe 950mm | Schutzklasse I/II

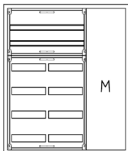
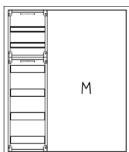
Kompletttschränke

AD = Abdeckung
MP = Montageplatte
TE = Teilungseinheiten

Höhe 950mm

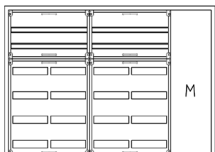
für Reihenklammen

<p>AVB/K 1-6-210 UVB/K 1-6-210</p>  <p>2x AD 48 TE</p> <p>300mm x 950mm</p>	<p>AVB/K 1-6-210-M1 UVB/K 1-6-210-M1</p>  <p>1x MP</p> <p>300mm x 950mm</p>	<p>AVB/K 2-6-210 UVB/K 2-6-210</p>  <p>2x AD 96 TE</p> <p>550mm x 950mm</p>	<p>AVB/K 2-6-210-S UVB/K 2-6-210-S</p>  <p>4x AD 96 TE</p> <p>550mm x 950mm</p>
<p>AVB/K 2-6-210-M1 UVB/K 2-6-210-M1</p>  <p>2x AD 1x MP 48 TE</p> <p>550mm x 950mm</p>	<p>AVB/K 2-6-210-M2 UVB/K 2-6-210-M2</p>  <p>1x MP</p> <p>550mm x 950mm</p>	<p>AVB/K 3-6-210-S UVB/K 3-6-210-S</p>  <p>4x AD 144 TE</p> <p>800mm x 950mm</p>	<p>AVB/K 3-6-210-M1 UVB/K 3-6-210-M1</p>  <p>2x AD 1x MP 96 TE</p> <p>800mm x 950mm</p>
<p>AVB/K 3-6-210-M2 UVB/K 3-6-210-M2</p>  <p>2x AD 1x MP 48 TE</p> <p>800mm x 950mm</p>	<p>AVB/K 4-6-210 UVB/K 4-6-210</p>  <p>4x AD 192 TE</p> <p>1050mm x 950mm</p>	<p>AVB/K 4-6-210-S UVB/K 4-6-210-S</p>  <p>6x AD 192 TE</p> <p>1050mm x 950mm</p>	<p>AVB/K 4-6-210-M1 UVB/K 4-6-210-M1</p>  <p>4x AD 1x MP 144 TE</p> <p>1050mm x 950mm</p>
<p>AVB/K 4-6-210-M2 UVB/K 4-6-210-M2</p>  <p>2x AD 1x MP 96 TE</p> <p>1050mm x 950mm</p>	<p>AVB/K 5-6-210-S UVB/K 5-6-210-S</p>  <p>6x AD 240 TE</p> <p>1300mm x 950mm</p>	<p>AVB/K 5-6-210-M1 UVB/K 5-6-210-M1</p>  <p>4x AD 1x MP 192 TE</p> <p>1300mm x 950mm</p>	<p>AVB/K 5-6-210-M2 UVB/K 5-6-210-M2</p>  <p>4x AD 1x MP 144 TE</p> <p>1300mm x 950mm</p>

Automatenverteiler Bautiefe 210mm









Höhe 1100mm | Schutzklasse I/II

Komplettsschränke

AD = Abdeckung
MP = Montageplatte
TE = Teilungseinheiten

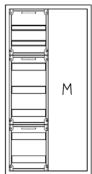
Höhe 1100mm

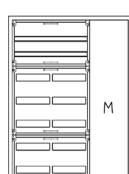
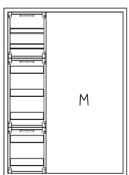
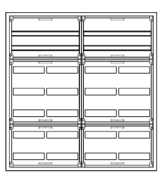
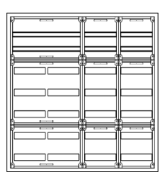
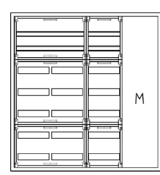
für Reihenklemmen

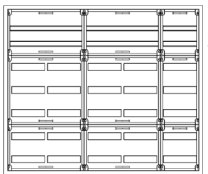
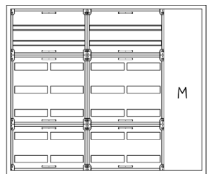
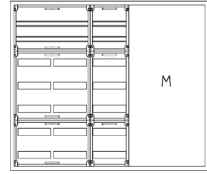
<p>AVB/K 1-7-210 UVB/K 1-7-210</p>  <p>3x AD 60 TE</p> <p>300mm x 1100mm</p>	<p>AVB/K 1-7-210-M1 UVB/K 1-7-210-M1</p>  <p>1x MP</p> <p>300mm x 1100mm</p>	<p>AVB/K 2-7-210 UVB/K 2-7-210</p>  <p>3x AD 120 TE</p> <p>550mm x 1100mm</p>	<p>AVB/K 2-7-210-S UVB/K 2-7-210-S</p>  <p>6x AD 120 TE</p> <p>550mm x 1100mm</p>
<p>AVB/K 2-7-210-M1 UVB/K 2-7-210-M1</p>  <p>3x AD 1x MP 60 TE</p> <p>550mm x 1100mm</p>	<p>AVB/K 2-7-210-M2 UVB/K 2-7-210-M2</p>  <p>1x MP</p> <p>550mm x 1100mm</p>	<p>AVB/K 3-7-210-S UVB/K 3-7-210-S</p>  <p>6x AD 180 TE</p> <p>800mm x 1100mm</p>	<p>AVB/K 3-7-210-M1 UVB/K 3-7-210-M1</p>  <p>3x AD 1x MP 120 TE</p> <p>800mm x 1100mm</p>
<p>AVB/K 3-7-210-M2 UVB/K 3-7-210-M2</p>  <p>3x AD 1x MP 60 TE</p> <p>800mm x 1100mm</p>	<p>AVB/K 4-7-210 UVB/K 4-7-210</p>  <p>6x AD 240 TE</p> <p>1050mm x 1100mm</p>	<p>AVB/K 4-7-210-S UVB/K 4-7-210-S</p>  <p>9x AD 240 TE</p> <p>1050mm x 1100mm</p>	<p>AVB/K 4-7-210-M1 UVB/K 4-7-210-M1</p>  <p>6x AD 1x MP 180 TE</p> <p>1050mm x 1100mm</p>
<p>AVB/K 4-7-210-M2 UVB/K 4-7-210-M2</p>  <p>3x AD 1x MP 120 TE</p> <p>1050mm x 1100mm</p>	<p>AVB/K 5-7-210-S UVB/K 5-7-210-S</p>  <p>9x AD 300 TE</p> <p>1300mm x 1100mm</p>	<p>AVB/K 5-7-210-M1 UVB/K 5-7-210-M1</p>  <p>6x AD 1x MP 240 TE</p> <p>1300mm x 1100mm</p>	<p>AVB/K 5-7-210-M2 UVB/K 5-7-210-M2</p>  <p>6x AD 1x MP 180 TE</p> <p>1300mm x 1100mm</p>

Automatenverteiler Bautiefe 210mm







Höhe 1250mm | Schutzklasse I/II

Komplettschränke

AD = Abdeckung
MP = Montageplatte
TE = Teilungseinheiten

Höhe 1250mm

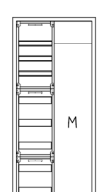
für Reihenklemmen

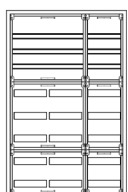
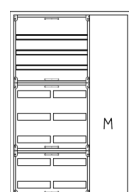
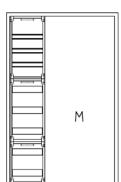
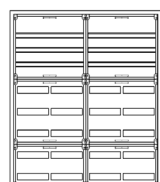
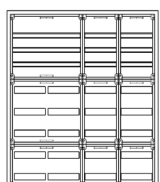
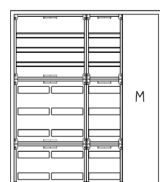
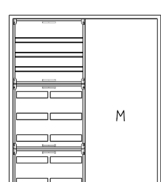
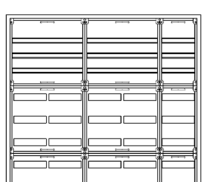
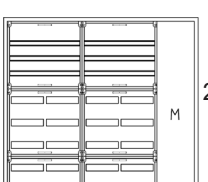
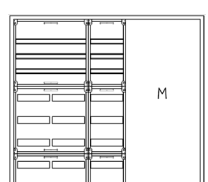
<p>AVB/K 1-8-210 UVB/K 1-8-210</p>  <p>3x AD 60 TE</p> <p>300mm x 1250mm</p>	<p>AVB/K 1-8-210-M1 UVB/K 1-8-210-M1</p>  <p>1x MP</p> <p>300mm x 1250mm</p>	<p>AVB/K 2-8-210 UVB/K 2-8-210</p>  <p>3x AD 120 TE</p> <p>550mm x 1250mm</p>	<p>AVB/K 2-8-210-S UVB/K 2-8-210-S</p>  <p>6x AD 120 TE</p> <p>550mm x 1250mm</p>
<p>AVB/K 2-8-210-M1 UVB/K 2-8-210-M1</p>  <p>3x AD 1x MP 60 TE</p> <p>550mm x 1250mm</p>	<p>AVB/K 2-8-210-M2 UVB/K 2-8-210-M2</p>  <p>1x MP</p> <p>550mm x 1250mm</p>	<p>AVB/K 3-8-210-S UVB/K 3-8-210-S</p>  <p>6x AD 180 TE</p> <p>800mm x 1250mm</p>	<p>AVB/K 3-8-210-M1 UVB/K 3-8-210-M1</p>  <p>3x AD 1x MP 120 TE</p> <p>800mm x 1250mm</p>
<p>AVB/K 3-8-210-M2 UVB/K 3-8-210-M2</p>  <p>3x AD 1x MP 60 TE</p> <p>800mm x 1250mm</p>	<p>AVB/K 4-8-210 UVB/K 4-8-210</p>  <p>6x AD 240 TE</p> <p>1050mm x 1250mm</p>	<p>AVB/K 4-8-210-S UVB/K 4-8-210-S</p>  <p>9x AD 240 TE</p> <p>1050mm x 1250mm</p>	<p>AVB/K 4-8-210-M1 UVB/K 4-8-210-M1</p>  <p>6x AD 1x MP 180 TE</p> <p>1050mm x 1250mm</p>
<p>AVB/K 4-8-210-M2 UVB/K 4-8-210-M2</p>  <p>3x AD 1x MP 120 TE</p> <p>1050mm x 1250mm</p>	<p>AVB/K 5-8-210-S UVB/K 5-8-210-S</p>  <p>9x AD 300 TE</p> <p>1300mm x 1250mm</p>	<p>AVB/K 5-8-210-M1 UVB/K 5-8-210-M1</p>  <p>6x AD 1x MP 240 TE</p> <p>1300mm x 1250mm</p>	<p>AVB/K 5-8-210-M2 UVB/K 5-8-210-M2</p>  <p>6x AD 1x MP 180 TE</p> <p>1300mm x 1250mm</p>

Automatenverteiler Bautiefe 210mm











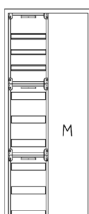

Höhe 1400mm | Schutzklasse I/II

Komplettschränke

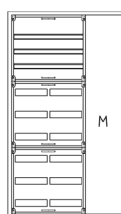
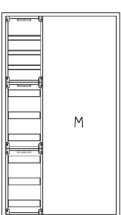
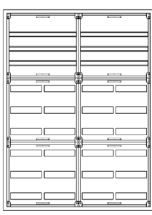
AD = Abdeckung
MP = Montageplatte
TE = Teilungseinheiten

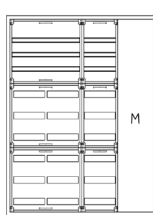
Höhe 1400mm

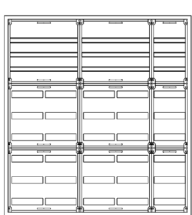
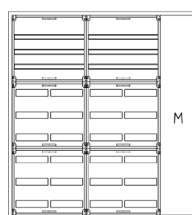
für Reihenklemmen

<p>AVB/K 1-9-210 UVB/K 1-9-210</p>  <p>3x AD 72 TE</p> <p>300mm x 1400mm</p>	<p>AVB/K 1-9-210-M1 UVB/K 1-9-210-M1</p>  <p>1x MP</p> <p>300mm x 1400mm</p>	<p>AVB/K 2-9-210 UVB/K 2-9-210</p>  <p>3x AD 144 TE</p> <p>550mm x 1400mm</p>	<p>AVB/K 2-9-210-S UVB/K 2-9-210-S</p>  <p>6x AD 144 TE</p> <p>550mm x 1400mm</p>
<p>AVB/K 2-9-210-M1 UVB/K 2-9-210-M1</p>  <p>3x AD 1x MP 72 TE</p> <p>550mm x 1400mm</p>	<p>AVB/K 2-9-210-M2 UVB/K 2-9-210-M2</p>  <p>1x MP</p> <p>550mm x 1400mm</p>	<p>AVB/K 3-9-210-S UVB/K 3-9-210-S</p>  <p>6x AD 216 TE</p> <p>800mm x 1400mm</p>	<p>AVB/K 3-9-210-M1 UVB/K 3-9-210-M1</p>  <p>3x AD 1x MP 144 TE</p> <p>800mm x 1400mm</p>
<p>AVB/K 3-9-210-M2 UVB/K 3-9-210-M2</p>  <p>3x AD 1x MP 72 TE</p> <p>800mm x 1400mm</p>	<p>AVB/K 4-9-210 UVB/K 4-9-210</p>  <p>6x AD 288 TE</p> <p>1050mm x 1400mm</p>	<p>AVB/K 4-9-210-S UVB/K 4-9-210-S</p>  <p>9x AD 288 TE</p> <p>1050mm x 1400mm</p>	<p>AVB/K 4-9-210-M1 UVB/K 4-9-210-M1</p>  <p>6x AD 1x MP 216 TE</p> <p>1050mm x 1400mm</p>
<p>AVB/K 4-9-210-M2 UVB/K 4-9-210-M2</p>  <p>3x AD 1x MP 144 TE</p> <p>1050mm x 1400mm</p>	<p>AVB/K 5-9-210-S UVB/K 5-9-210-S</p>  <p>9x AD 360 TE</p> <p>1300mm x 1400mm</p>	<p>AVB/K 5-9-210-M1 UVB/K 5-9-210-M1</p>  <p>6x AD 1x MP 288 TE</p> <p>1300mm x 1400mm</p>	<p>AVB/K 5-9-210-M2 UVB/K 5-9-210-M2</p>  <p>6x AD 1x MP 216 TE</p> <p>1300mm x 1400mm</p>

Automatenverteiler Bautiefe 210mm | 230mm

MP auf Rückwand | Höhe 800-1400mm | Schutzklasse I

- für den Innenbereich
 - Schutzart: IP 41
 - **AVB**: Schutzklasse I (geerdet)
 - **AVK**: Wandbefestigung Aufputz
 - **AVBM**-Schränke mit Montageplatte gelocht auf Rückwand
 - kein Einbau von Abdeckungen möglich
-
- Bautiefe 210mm: - Farbe: RAL 9016
 - Einzeltür mit Drehverschluss, ab 3 Feldbreiten (800mm) Doppeltür
 - Kabeleinführungen: NF1w (oben) und NF2w (unten)
 - Bautiefe 230mm: - Farbe: RAL 7035
 - Einzeltür mit Schwenkhebel, ab 4 Feldbreiten (1050mm) Doppeltür
 - Kabeleinführungen: SF45 (oben) und SF41 (unten)

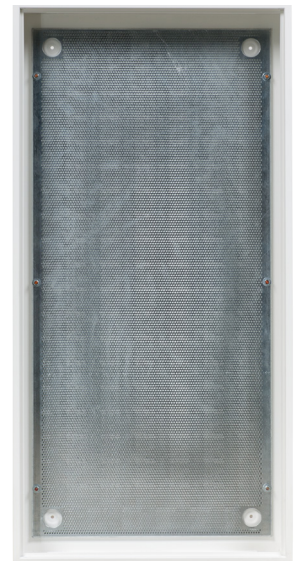

Komplettschränke

Höhe 800mm

AVBM 2-5-210
AVBM 2-5-230
550mm x 800mm

AVBM 3-5-210
AVBM 3-5-230
800mm x 800mm

AVBM 4-5-210
AVBM 4-5-230
1050mm x 800mm

Höhe 950mm

AVBM 2-6-210
AVBM 2-6-230
550mm x 950mm

AVBM 3-6-210
AVBM 3-6-230
800mm x 950mm

AVBM 4-6-210
AVBM 4-6-230
1050mm x 950mm

Höhe 1100mm

AVBM 2-7-210
AVBM 2-7-230
550mm x 1100mm

AVBM 3-7-210
AVBM 3-7-230
800mm x 1100mm

AVBM 4-7-210
AVBM 4-7-230
1050mm x 1100mm

Höhe 1250mm

AVBM 2-8-210
AVBM 2-8-230
550mm x 1250mm

AVBM 3-8-210
AVBM 3-8-230
800mm x 1250mm

AVBM 4-8-210
AVBM 4-8-230
1050mm x 1250mm

Höhe 1400mm

AVBM 2-9-210
AVBM 2-9-230
550mm x 1400mm

AVBM 3-9-210
AVBM 3-9-230
800mm x 1400mm

AVBM 4-9-210
AVBM 4-9-230
1050mm x 1400mm

Automatenverteiler Bautiefe 230mm

Höhe 650mm | Schutzklasse I/II

- für den Innenbereich
- Farbe: RAL 7035
- Schutzart: IP 54
- **AVB**: Schutzklasse I (geerdet)
- **AVK**: Schutzklasse II (schutzisoliert)
- Wandbefestigung Aufputz (**AVB/AVK**)
- Einzeltür mit Schwenkhebel, ab 4 Feldbreiten (1050mm) Doppeltür
- Kabeleinführungen: SF45 (oben) und SF41 (unten)
- Geräteträger: für Reihenklemmen mit Feldabdeckung PRL; Reihenabstand 150mm
- **S**-Schränke mit zusätzlichem einzelnen Geräteträger
- **M**-Schränke mit Montageplatte gelocht:
 - M1-2 = gesamte Breite der Montageplatte(n) 1-2 Feldbreiten











Auf Wunsch auch mit PS Abdeckungen (**P**):

Bestellbeispiel: Artikelnummer + zusätzliches P: **AVK2-4-230-M1-P**

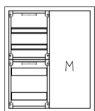
Komplettschränke

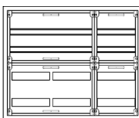
AD = Abdeckung
MP = Montageplatte
TE = Teilungseinheiten

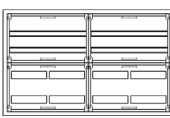
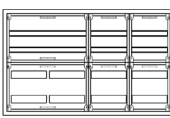
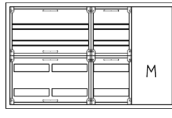
Höhe 650mm		für Reihenklemmen	
<p>AVK 1-4-230 AVB 1-4-230</p>  <p>2x AD 24 TE</p> <p>300mm x 650mm</p>	<p>AVK 1-4-230-M1 AVB 1-4-230-M1</p>  <p>1x MP</p> <p>300mm x 650mm</p>	<p>AVK 2-4-230 AVB 2-4-230</p>  <p>2x AD 48 TE</p> <p>550mm x 650mm</p>	<p>AVK 2-4-230-S AVB 2-4-230-S</p>  <p>4x AD 48 TE</p> <p>550mm x 650mm</p>
<p>AVK 2-4-230-M1 AVB 2-4-230-M1</p>  <p>2x AD 1x MP 24 TE</p> <p>550mm x 650mm</p>	<p>AVK 2-4-230-M2 AVB 2-4-230-M2</p>  <p>1x MP</p> <p>550mm x 650mm</p>	<p>AVK 3-4-230-S AVB 3-4-230-S</p>  <p>4x AD 72 TE</p> <p>800mm x 650mm</p>	<p>AVK 3-4-230-M1 AVB 3-4-230-M1</p>  <p>2x AD 1x MP 48 TE</p> <p>800mm x 650mm</p>
<p>AVK 3-4-230-M2 AVB 3-4-230-M2</p>  <p>2x AD 1x MP 24 TE</p> <p>800mm x 650mm</p>	<p>AVK 4-4-230 AVB 4-4-230</p>  <p>4x AD 96 TE</p> <p>1050mm x 650mm</p>	<p>AVK 4-4-230-S AVB 4-4-230-S</p>  <p>6x AD 96 TE</p> <p>1050mm x 650mm</p>	<p>AVK 4-4-230-M1 AVB 4-4-230-M1</p>  <p>4x AD 1x MP 72 TE</p> <p>1050mm x 650mm</p>

Automatenverteiler Bautiefe 230mm











Höhe 650mm | 800mm | Schutzklasse I/II

Komplettsschränke

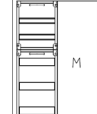
AD = Abdeckung
MP = Montageplatte
TE = Teilungseinheiten

Höhe 650mm | 800mm

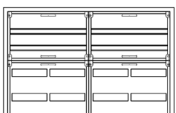
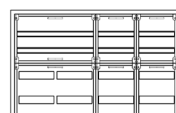
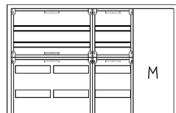
für Reihenklemmen

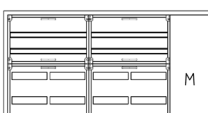
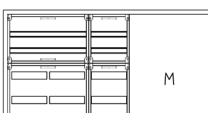
<p>AVK 4-4-230-M2 AVB 4-4-230-M2</p>  <p>2x AD 1x MP 48 TE</p> <p>1050mm x 650mm</p>			
<p>AVK 1-5-230 AVB 1-5-230</p>  <p>2x AD 36 TE</p> <p>300mm x 800mm</p>	<p>AVK 1-5-230-M1 AVB 1-5-230-M1</p>  <p>1x MP</p> <p>300mm x 800mm</p>	<p>AVK 2-5-230 AVB 2-5-230</p>  <p>2x AD 72 TE</p> <p>550mm x 800mm</p>	<p>AVK 2-5-230-S AVB 2-5-230-S</p>  <p>4x AD 72 TE</p> <p>550mm x 800mm</p>
<p>AVK 2-5-230-M1 AVB 2-5-230-M1</p>  <p>2x AD 1x MP 36 TE</p> <p>550mm x 800mm</p>	<p>AVK 2-5-230-M2 AVB 2-5-230-M2</p>  <p>1x MP</p> <p>550mm x 800mm</p>	<p>AVK 3-5-230-S AVB 3-5-230-S</p>  <p>4x AD 108 TE</p> <p>800mm x 800mm</p>	<p>AVK 3-5-230-M1 AVB 3-5-230-M1</p>  <p>2x AD 1x MP 72 TE</p> <p>800mm x 800mm</p>
<p>AVK 3-5-230-M2 AVB 3-5-230-M2</p>  <p>2x AD 1x MP 36 TE</p> <p>800mm x 800mm</p>	<p>AVK 4-5-230 AVB 4-5-230</p>  <p>4x AD 144 TE</p> <p>1050mm x 800mm</p>	<p>AVK 4-5-230-S AVB 4-5-230-S</p>  <p>6x AD 144 TE</p> <p>1050mm x 800mm</p>	<p>AVK 4-5-230-M1 AVB 4-5-230-M1</p>  <p>4x AD 1x MP 108 TE</p> <p>1050mm x 800mm</p>
<p>AVK 4-5-230-M2 AVB 4-5-230-M2</p>  <p>2x AD 1x MP 72 TE</p> <p>1050mm x 800mm</p>	<p>AVK 5-5-230-S AVB 5-5-230-S</p>  <p>6x AD 180 TE</p> <p>1300mm x 800mm</p>	<p>AVK 5-5-230-M1 AVB 5-5-230-M1</p>  <p>4x AD 1x MP 144 TE</p> <p>1300mm x 800mm</p>	<p>AVK 5-5-230-M2 AVB 5-5-230-M2</p>  <p>4x AD 1x MP 108 TE</p> <p>1300mm x 800mm</p>

Automatenverteiler Bautiefe 230mm











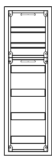

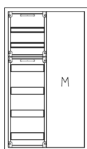

Höhe 950mm | Schutzklasse I/II

Komplettsschränke

AD = Abdeckung
MP = Montageplatte
TE = Teilungseinheiten

Höhe 950mm

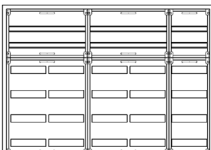
für Reihenklemmen

<p>AVK 1-6-230 AVB 1-6-230</p>  <p>2x AD 48 TE</p> <p>300mm x 950mm</p>	<p>AVK 1-6-230-M1 AVB 1-6-230-M1</p>  <p>1x MP</p> <p>300mm x 950mm</p>	<p>AVK 2-6-230 AVB 2-6-230</p>  <p>2x AD 96 TE</p> <p>550mm x 950mm</p>	<p>AVK 2-6-230-S AVB 2-6-230-S</p>  <p>4x AD 96 TE</p> <p>550mm x 950mm</p>
<p>AVK 2-6-230-M1 AVB 2-6-230-M1</p>  <p>2x AD 1x MP 48 TE</p> <p>550mm x 950mm</p>	<p>AVK 2-6-230-M2 AVB 2-6-230-M2</p>  <p>1x MP</p> <p>550mm x 950mm</p>	<p>AVK 3-6-230-S AVB 3-6-230-S</p>  <p>4x AD 144 TE</p> <p>800mm x 950mm</p>	<p>AVK 3-6-230-M1 AVB 3-6-230-M1</p>  <p>2x AD 1x MP 96 TE</p> <p>800mm x 950mm</p>
<p>AVK 3-6-230-M2 AVB 3-6-230-M2</p>  <p>2x AD 1x MP 48 TE</p> <p>800mm x 950mm</p>	<p>AVK 4-6-230 AVB 4-6-230</p>  <p>4x AD 192 TE</p> <p>1050mm x 950mm</p>	<p>AVK 4-6-230-S AVB 4-6-230-S</p>  <p>6x AD 192 TE</p> <p>1050mm x 950mm</p>	<p>AVK 4-6-230-M1 AVB 4-6-230-M1</p>  <p>4x AD 1x MP 144 TE</p> <p>1050mm x 950mm</p>
<p>AVK 4-6-230-M2 AVB 4-6-230-M2</p>  <p>2x AD 1x MP 96 TE</p> <p>1050mm x 950mm</p>	<p>AVK 5-6-230-S AVB 5-6-230-S</p>  <p>6x AD 240 TE</p> <p>1300mm x 950mm</p>	<p>AVK 5-6-230-M1 AVB 5-6-230-M1</p>  <p>4x AD 1x MP 192 TE</p> <p>1300mm x 950mm</p>	<p>AVK 5-6-230-M2 AVB 5-6-230-M2</p>  <p>4x AD 1x MP 144 TE</p> <p>1300mm x 950mm</p>

Automatenverteiler Bautiefe 230mm









Höhe 1100mm | Schutzklasse I/II

Kompletttschränke

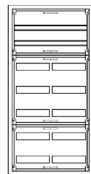
AD = Abdeckung
MP = Montageplatte
TE = Teilungseinheiten

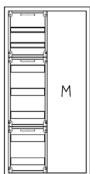
Höhe 1100mm

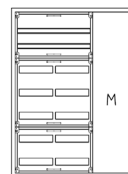
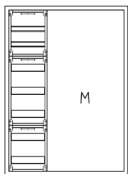
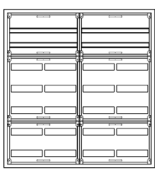
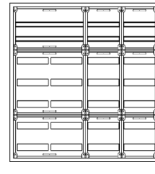
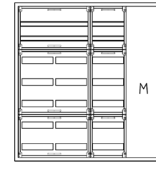
für Reihenklemmen

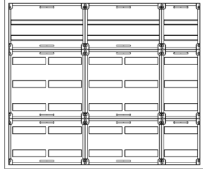
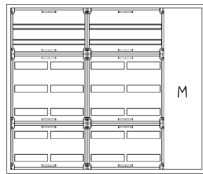
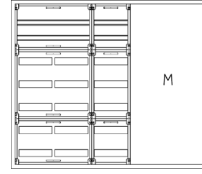
<p>AVK 1-7-230 AVB 1-7-230</p>  <p>3x AD 60 TE</p> <p>300mm x 1100mm</p>	<p>AVK 1-7-230-M1 AVB 1-7-230-M1</p>  <p>1x MP</p> <p>300mm x 1100mm</p>	<p>AVK 2-7-230 AVB 2-7-230</p>  <p>3x AD 120 TE</p> <p>550mm x 1100mm</p>	<p>AVK 2-7-230-S AVB 2-7-230-S</p>  <p>6x AD 120 TE</p> <p>550mm x 1100mm</p>
<p>AVK 2-7-230-M1 AVB 2-7-230-M1</p>  <p>3x AD 1x MP 60 TE</p> <p>550mm x 1100mm</p>	<p>AVK 2-7-230-M2 AVB 2-7-230-M2</p>  <p>1x MP</p> <p>550mm x 1100mm</p>	<p>AVK 3-7-230-S AVB 3-7-230-S</p>  <p>6x AD 180 TE</p> <p>800mm x 1100mm</p>	<p>AVK 3-7-230-M1 AVB 3-7-230-M1</p>  <p>3x AD 1x MP 120 TE</p> <p>800mm x 1100mm</p>
<p>AVK 3-7-230-M2 AVB 3-7-230-M2</p>  <p>3x AD 1x MP 60 TE</p> <p>800mm x 1100mm</p>	<p>AVK 4-7-230 AVB 4-7-230</p>  <p>6x AD 240 TE</p> <p>1050mm x 1100mm</p>	<p>AVK 4-7-230-S AVB 4-7-230-S</p>  <p>9x AD 240 TE</p> <p>1050mm x 1100mm</p>	<p>AVK 4-7-230-M1 AVB 4-7-230-M1</p>  <p>6x AD 1x MP 180 TE</p> <p>1050mm x 1100mm</p>
<p>AVK 4-7-230-M2 AVB 4-7-230-M2</p>  <p>3x AD 1x MP 120 TE</p> <p>1050mm x 1100mm</p>	<p>AVK 5-7-230-S AVB 5-7-230-S</p>  <p>9x AD 300 TE</p> <p>1300mm x 1100mm</p>	<p>AVK 5-7-230-M1 AVB 5-7-230-M1</p>  <p>6x AD 1x MP 240 TE</p> <p>1300mm x 1100mm</p>	<p>AVK 5-7-230-M2 AVB 5-7-230-M2</p>  <p>6x AD 1x MP 180 TE</p> <p>1300mm x 1100mm</p>

Automatenverteiler Bautiefe 230mm







Höhe 1250mm | Schutzklasse I/II

Komplettsschränke

AD = Abdeckung
MP = Montageplatte
TE = Teilungseinheiten

Höhe 1250mm

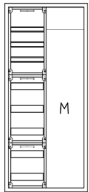
für Reihenklammern

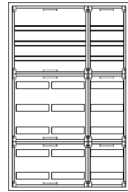
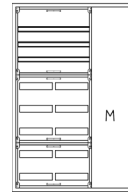
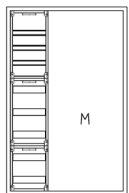
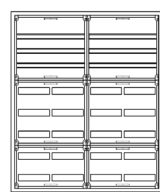
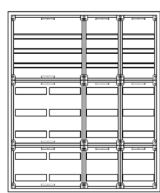
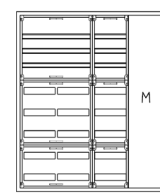
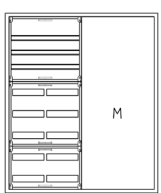
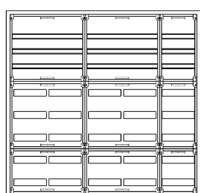
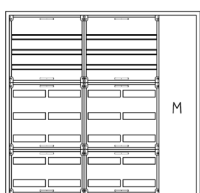
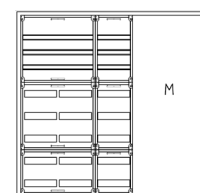
<p>AVK 1-8-230 AVB 1-8-230</p>  <p>3x AD 60 TE</p> <p>300mm x 1250mm</p>	<p>AVK 1-8-230-M1 AVB 1-8-230-M1</p>  <p>1x MP</p> <p>300mm x 1250mm</p>	<p>AVK 2-8-230 AVB 2-8-230</p>  <p>3x AD 120 TE</p> <p>550mm x 1250mm</p>	<p>AVK 2-8-230-S AVB 2-8-230-S</p>  <p>6x AD 120 TE</p> <p>550mm x 1250mm</p>
<p>AVK 2-8-230-M1 AVB 2-8-230-M1</p>  <p>3x AD 1x MP 60 TE</p> <p>550mm x 1250mm</p>	<p>AVK 2-8-230-M2 AVB 2-8-230-M2</p>  <p>1x MP</p> <p>550mm x 1250mm</p>	<p>AVK 3-8-230-S AVB 3-8-230-S</p>  <p>6x AD 180 TE</p> <p>800mm x 1250mm</p>	<p>AVK 3-8-230-M1 AVB 3-8-230-M1</p>  <p>3x AD 1x MP 120 TE</p> <p>800mm x 1250mm</p>
<p>AVK 3-8-230-M2 AVB 3-8-230-M2</p>  <p>3x AD 1x MP 60 TE</p> <p>800mm x 1250mm</p>	<p>AVK 4-8-230 AVB 4-8-230</p>  <p>6x AD 240 TE</p> <p>1050mm x 1250mm</p>	<p>AVK 4-8-230-S AVB 4-8-230-S</p>  <p>9x AD 240 TE</p> <p>1050mm x 1250mm</p>	<p>AVK 4-8-230-M1 AVB 4-8-230-M1</p>  <p>6x AD 1x MP 180 TE</p> <p>1050mm x 1250mm</p>
<p>AVK 4-8-230-M2 AVB 4-8-230-M2</p>  <p>3x AD 1x MP 120 TE</p> <p>1050mm x 1250mm</p>	<p>AVK 5-8-230-S AVB 5-8-230-S</p>  <p>9x AD 300 TE</p> <p>1300mm x 1250mm</p>	<p>AVK 5-8-230-M1 AVB 5-8-230-M1</p>  <p>6x AD 1x MP 240 TE</p> <p>1300mm x 1250mm</p>	<p>AVK 5-8-230-M2 AVB 5-8-230-M2</p>  <p>6x AD 1x MP 180 TE</p> <p>1300mm x 1250mm</p>

Automatenverteiler Bautiefe 230mm











Höhe 1400mm | Schutzklasse I/II

Komplettschränke

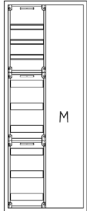
AD = Abdeckung
MP = Montageplatte
TE = Teilungseinheiten

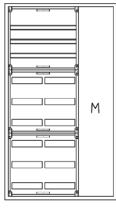
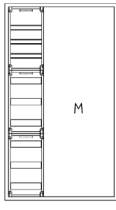
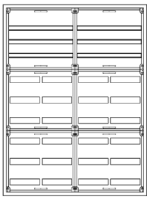
Höhe 1400mm

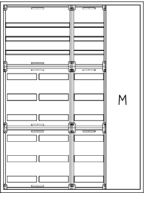
für Reihenklemmen

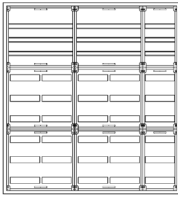
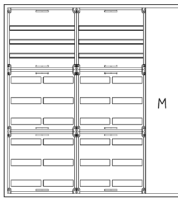
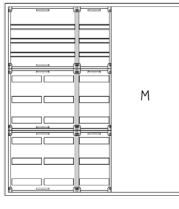
<p>AVK 1-9-230 AVB 1-9-230</p>  <p>3x AD 72 TE</p> <p>300mm x 1400mm</p>	<p>AVK 1-9-230-M1 AVB 1-9-230-M1</p>  <p>1x MP</p> <p>300mm x 1400mm</p>	<p>AVK 2-9-230 AVB 2-9-230</p>  <p>3x AD 144 TE</p> <p>550mm x 1400mm</p>	<p>AVK 2-9-230-S AVB 2-9-230-S</p>  <p>6x AD 144 TE</p> <p>550mm x 1400mm</p>
<p>AVK 2-9-230-M1 AVB 2-9-230-M1</p>  <p>3x AD 1x MP 72 TE</p> <p>550mm x 1400mm</p>	<p>AVK 2-9-230-M2 AVB 2-9-230-M2</p>  <p>1x MP</p> <p>550mm x 1400mm</p>	<p>AVK 3-9-230-S AVB 3-9-230-S</p>  <p>6x AD 216 TE</p> <p>800mm x 1400mm</p>	<p>AVK 3-9-230-M1 AVB 3-9-230-M1</p>  <p>3x AD 1x MP 144 TE</p> <p>800mm x 1400mm</p>
<p>AVK 3-9-230-M2 AVB 3-9-230-M2</p>  <p>3x AD 1x MP 72 TE</p> <p>800mm x 1400mm</p>	<p>AVK 4-9-230 AVB 4-9-230</p>  <p>6x AD 288 TE</p> <p>1050mm x 1400mm</p>	<p>AVK 4-9-230-S AVB 4-9-230-S</p>  <p>9x AD 288 TE</p> <p>1050mm x 1400mm</p>	<p>AVK 4-9-230-M1 AVB 4-9-230-M1</p>  <p>6x AD 1x MP 216 TE</p> <p>1050mm x 1400mm</p>
<p>AVK 4-9-230-M2 AVB 4-9-230-M2</p>  <p>3x AD 1x MP 144 TE</p> <p>1050mm x 1400mm</p>	<p>AVK 5-9-230-S AVB 5-9-230-S</p>  <p>9x AD 360 TE</p> <p>1300mm x 1400mm</p>	<p>AVK 5-9-230-M1 AVB 5-9-230-M1</p>  <p>6x AD 1x MP 288 TE</p> <p>1300mm x 1400mm</p>	<p>AVK 5-9-230-M2 AVB 5-9-230-M2</p>  <p>6x AD 1x MP 216 TE</p> <p>1300mm x 1400mm</p>

Montageplatte gelocht

- Material: Stahlblech verzinkt 1,5mm, Lochdurchmesser 3,2mm
- Einbau auf Geräteträger

Bestehend aus:

- 1x Montageplatte (z.B. MP12)
- 1x Befestigungssatz nach Schutzart und Bauhöhe (z.B. S16)

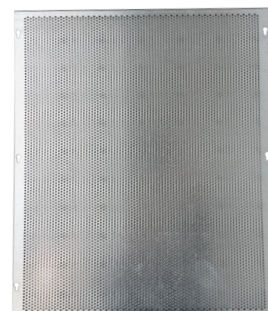

Bestellbeispiel: **MP12-S16** = Montageplatte 250 x 300mm mit Befestigungssatz der Schutzklasse II

Montageplatte (MP):

Höhe/Breite	250mm	500mm
150mm	MP11	MP21
300mm	MP12	MP22
450mm	MP13	MP23
600mm	MP14	MP24
750mm	MP15	MP25
900mm	MP16	MP26
1050mm	MP17	MP27
1200mm	MP18	MP28
1350mm	MP19	MP29

Befestigungssatz:

Schutzklasse I	Schutzklasse II
<p>Z35 MP wird dadurch 35mm versetzt aufgeschraubt</p>	<p>S16 MP wird dadurch 16mm versetzt aufgeschraubt</p>
<p>Z57 MP wird dadurch 57mm versetzt aufgeschraubt</p>	<p>S35 MP wird dadurch 35mm versetzt aufgeschraubt</p>
<p>Z96 MP wird dadurch 96mm versetzt aufgeschraubt</p>	

Feldabdeckungen

PS I geschlossen I offen I BT 120-230mm

Feldabdeckungen geschlossen I PS

- Farbe lichtgrau (RAL 7035)
- Material: halogenfreies, selbstverlöschendes Polystyrol

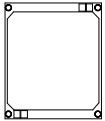
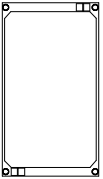
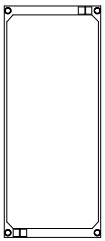
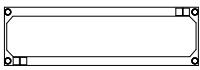
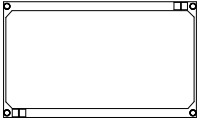
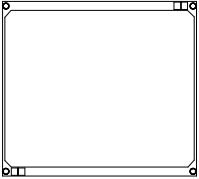
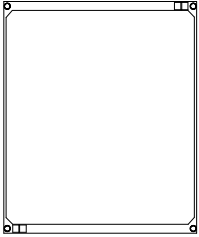

Feldhöhe	150mm	300mm	450mm	600mm
Feldbreite	FAG11PS	FAG12PS	FAG13PS	FAG14PS
250mm				
500mm	FAG21PS 	FAG22PS 	FAG23PS 	FAG24PS 

Feldabdeckungen offen I PS

- Farbe lichtgrau (RAL 7035)
- Material: halogenfreies, selbstverlöschendes Polystyrol

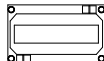
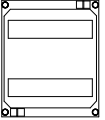
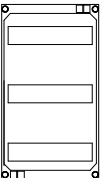
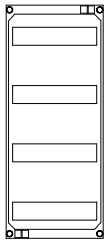
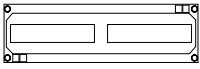
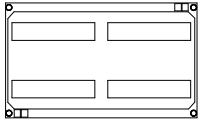
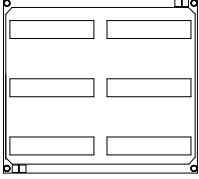
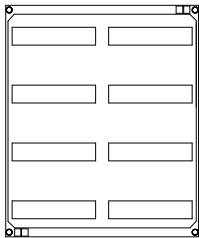

(Schlitzmaß: 46x216mm, Reihenabstand: 150mm)

Feldhöhe	150mm	300mm	450mm	600mm
Feldbreite	FAO11PS-150	FAO12PS-150	FAO13PS-150	FAO14PS-150
250mm				
500mm	FAO21PS-150 	FAO22PS-150 	FAO23PS-150 	FAO24PS-150 

Feldabdeckungen offen für Sammelschienensysteme I PRL

- für Neozed oder NH-Lasttrenner auf Sammelschiene Mittenabstand 60mm
- Farbe lichtgrau (RAL 7035)
- Material: halogenfreies, selbstverlöschendes Polystyrol

Bestehend aus:

- 1x Feldabdeckung
- 1x bzw. 2x Haltegriff
- 4x Vierteldrehverschluss

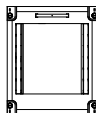
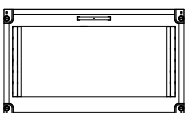
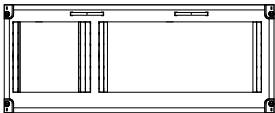
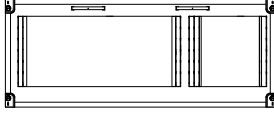

Feldhöhe	300mm	
Feldbreite		
250mm	<p>FAS12NEO</p> 	<p>- Feldabdeckung 1-Feld Abmaße (BxH): 250x300mm Ausschnitt: 162x196mm Auslösbar bis 202x196mm</p>
500mm	<p>FAS22NEO</p> 	<p>- Feldabdeckung 2-Feld Abmaße (BxH): 500x300mm Ausschnitt: 404x196mm Auslösbar bis 452x196mm</p>
750mm	<p>FAS32NEO-li</p> 	<p>- Feldabdeckung 3-Feld links Abmaße (BxH): 750x300m Ausschnitt links (1-Feld): 162x196mm Auslösbar bis 216x196mm Ausschnitt rechts (2-Feld): 404x196mm Auslösbar bis: 452x196mm</p>
750mm	<p>FASNEO-re</p> 	<p>- Feldabdeckung 3-Feld rechts Abmaße (BxH): 750x300m Ausschnitt links (2-Feld): 404x196mm Auslösbar bis 452x196mm Ausschnitt rechts (1-Feld): 162x196mm Auslösbar bis: 216x196mm</p>

Feldabdeckungen geschlossen I PRL







- Farbe lichtgrau (RAL 7035)
- Material: halogenfreies, selbstverlöschendes Polystyrol

Bestehend aus:

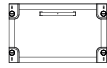
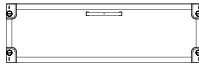
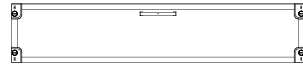
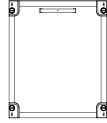
- 1x Feldabdeckung
- 1x bzw. 2x Haltegriff
- 4x Vierteldrehverschluss

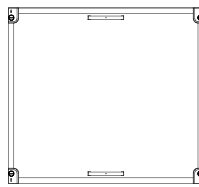
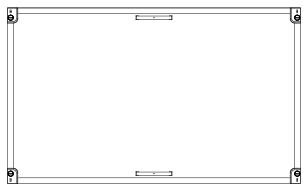

Durch die seitliche Abkantung ergibt sich eine Erhöhung der Einbautiefe um 30mm. Abdeckungen können gewendet werden. Dadurch sind zwei verschiedene Aufbauhöhen möglich.

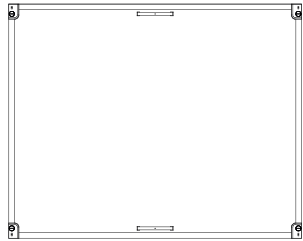
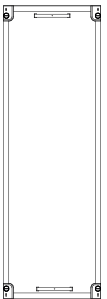
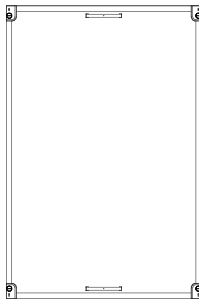
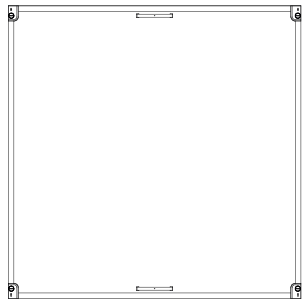
Feldbreite	250mm	500mm	750mm
Feldhöhe	FAG11PRL	FAG21PRL	FAG31PRL
150mm			
300mm	FAG12PRL	FAG22PRL	FAG32PRL
			
450mm	FAG13PRL	FAG23PRL	FAG33PRL
			
600mm	FAG14PRL	FAG24PRL	FAG34PRL
			
750mm	FAG15PRL	FAG25PRL	FAG35PRL
			

Feldabdeckungen offen I PRL

- Farbe lichtgrau (RAL 7035)
- Material: halogenfreies, selbstverlöschendes Polystyrol





Bestehend aus:

- 1x Feldabdeckung
- 1x bzw. 2x Haltegriff
- 4x Vierteldrehverschluss

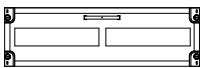

(Schlitzmaß: 46x216mm bzw. 46x450mm)

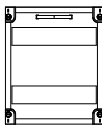
Durch die seitliche Abkantung ergibt sich eine Erhöhung der Einbautiefe um 30mm.
Abdeckungen können gewendet werden. Dadurch sind zwei verschiedene Aufbauhöhen möglich.

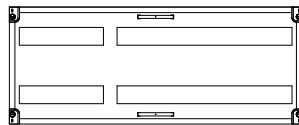
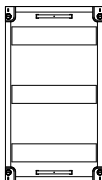
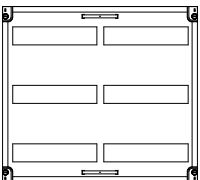
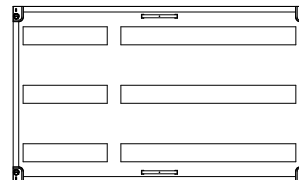
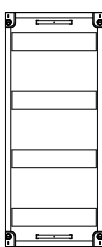
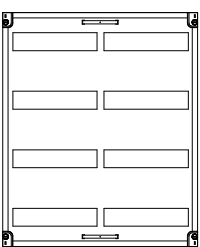
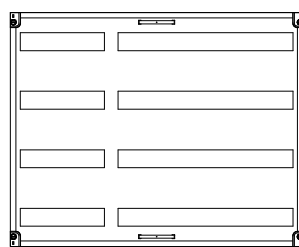
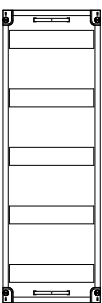
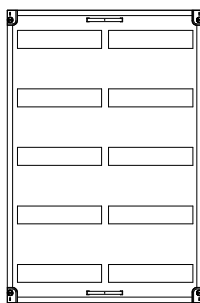
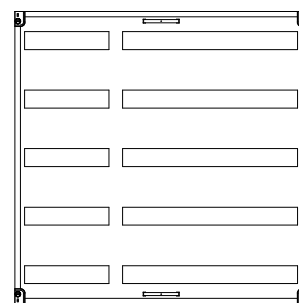
Feldbreite	250mm	500mm	750mm
Feldhöhe	FAO11PRL	FAO21PRL	FAO31PRL
150mm			
300mm	FAO12PRL	FAO22PRL	FAO32PRL
			
450mm	FAO13PRL	FAO23PRL	FAO33PRL
			
600mm	FAO14PRL	FAO24PRL	FAO34PRL
			
750mm	FAO15PRL	FAO25PRL	FAO35PRL
			



Schrank mit Sammelschienensystemen

Sammelschienensystem 5-polig komplett

60mm MIttenabstand

- Bestehend aus:
- 5x Sammelschiene-CU nach Tabelle
 - 2x Sammelschienenhalter 5-polig komplett
 - 2x Berührungsschutzwinkel 5-polig

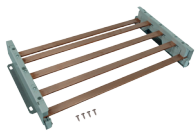

SSS-5pol-60-20-5-1

Bezeichnung	Felder	Artikelnummer
- Sammelschiene CU, BxH: 20x5 mm	1	SSS-5pol-60-20-5-1
- Sammelschiene CU, BxH: 20x5 mm	2	SSS-5pol-60-20-5-2
- Sammelschiene CU, BxH: 20x5 mm	3	SSS-5pol-60-20-5-3
- Sammelschiene CU, BxH: 30x5 mm	1	SSS-5pol-60-30-5-1
- Sammelschiene CU, BxH: 30x5 mm	2	SSS-5pol-60-30-5-2
- Sammelschiene CU, BxH: 30x5 mm	3	SSS-5pol-60-30-5-3
- Sammelschiene CU, BxH: 30x10 mm	1	SSS-5pol-60-30-10-1
- Sammelschiene CU, BxH: 30x10 mm	2	SSS-5pol-60-30-10-2
- Sammelschiene CU, BxH: 30x10 mm	3	SSS-5pol-60-30-10-3

Sammelschienensystem 5-polig Einzelbauteile



SSH-5pol-60

Bezeichnung	VPE	Artikelnummer
- Sammelschienenhalter 5-polig, bestehend aus:	1 20	SSH-5pol-60
- 1x Sammelschienenhalter		- 5x Distanzhülse
- 2x Befestigungsschraube 4,8x13		- 1x Haltewinkel
- 2x Befestigungsschraube 4,8x25		



BSW-5pol-60

Bezeichnung	VPE	Artikelnummer
- Berührungsschutzwinkel 5-polig, bestehend aus:	1 20	BSW-5pol-60
- 1x Berührungsschutzwinkel		
- 3x Plastofastschrauben 4x8		

Bezeichnung	Felder	Artikelnummer
- Sammelschiene CU, BxH: 20x5 mm	1	SS-5pol-20-5-1
- Sammelschiene CU, BxH: 20x5 mm	2	SS-5pol-20-5-2
- Sammelschiene CU, BxH: 20x5 mm	3	SS-5pol-20-5-3
- Sammelschiene CU, BxH: 30x5 mm	1	SS-5pol-30-5-1
- Sammelschiene CU, BxH: 30x5 mm	2	SS-5pol-30-5-2
- Sammelschiene CU, BxH: 30x5 mm	3	SS-5pol-30-5-3
- Sammelschiene CU, BxH: 30x10 mm	1	SS-5pol-30-10-1
- Sammelschiene CU, BxH: 30x10 mm	2	SS-5pol-30-10-2
- Sammelschiene CU, BxH: 30x10 mm	3	SS-5pol-30-10-3



Schrank mit Sammleschienensystemen

Sammelschienensystem 3-polig komplett

60mm Mittenabstand

- Bestehend aus:
- 3x Sammelschiene-CU nach Tabelle
 - 2x Sammelschienehalter 3-polig komplett
 - 2x Berührungsschutzwinkel 3-polig



SSS-3pol-60-20-5-1

Bezeichnung	Felder	Artikelnummer
- Sammelschiene CU, BxH: 20x5 mm	1	SSS-3pol-60-20-5-1
- Sammelschiene CU, BxH: 20x5 mm	2	SSS-3pol-60-20-5-2
- Sammelschiene CU, BxH: 20x5 mm	3	SSS-3pol-60-20-5-3
- Sammelschiene CU, BxH: 30x5 mm	1	SSS-3pol-60-30-5-1
- Sammelschiene CU, BxH: 30x5 mm	2	SSS-3pol-60-30-5-2
- Sammelschiene CU, BxH: 30x5 mm	3	SSS-3pol-60-30-5-3
- Sammelschiene CU, BxH: 30x10 mm	1	SSS-3pol-60-30-10-1
- Sammelschiene CU, BxH: 30x10 mm	2	SSS-3pol-60-30-10-2
- Sammelschiene CU, BxH: 30x10 mm	3	SSS-3pol-60-30-10-3

Sammelschienensystem 3-polig Einzelbauteile



SSH-3pol-60

Bezeichnung	VPE	Artikelnummer
- Sammelschienehalter 3-polig, bestehend aus: - 1x Sammelschienehalter - 2x Befestigungsschraube 4,8x25	1 20	SSH-3pol-60



BSW-3pol-60

Bezeichnung	VPE	Artikelnummer
- Berührungsschutzwinkel 3-polig, bestehend aus: - 1x Berührungsschutzwinkel - 2x Plastofastschrauben 4x8	1 20	BSW-3pol-60

Bezeichnung	Felder	Artikelnummer
- Sammelschiene CU, BxH: 20x5 mm	1	SSS-3pol-20-5-1
- Sammelschiene CU, BxH: 20x5 mm	2	SSS-3pol-20-5-2
- Sammelschiene CU, BxH: 20x5 mm	3	SSS-3pol-20-5-3
- Sammelschiene CU, BxH: 30x5 mm	1	SSS-3pol-30-5-1
- Sammelschiene CU, BxH: 30x5 mm	2	SSS-3pol-30-5-2
- Sammelschiene CU, BxH: 30x5 mm	3	SSS-3pol-30-5-3
- Sammelschiene CU, BxH: 30x10 mm	1	SSS-3pol-30-10-1
- Sammelschiene CU, BxH: 30x10 mm	2	SSS-3pol-30-10-2
- Sammelschiene CU, BxH: 30x10 mm	3	SSS-3pol-30-10-3

Sammelschienensystem 1-polig Einzelbauteile

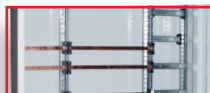

Schrank mit Sammelschienensystemen



Montagebeispiel

Bezeichnung	Felder	Artikelnummer
- Sammelschiene CU, BxH: 20x5 mm	1	SS-1pol-20-5-1
- Sammelschiene CU, BxH: 20x5 mm	2	SS-1pol-20-5-2
- Sammelschiene CU, BxH: 20x5 mm	3	SS-1pol-20-5-3
- Sammelschiene CU, BxH: 30x5 mm	1	SS-1pol-30-5-1
- Sammelschiene CU, BxH: 30x5 mm	2	SS-1pol-30-5-2
- Sammelschiene CU, BxH: 30x5 mm	3	SS-1pol-30-5-3
- Sammelschiene CU, BxH: 30x10 mm	1	SS-1pol-30-10-1
- Sammelschiene CU, BxH: 30x10 mm	2	SS-1pol-30-10-2
- Sammelschiene CU, BxH: 30x10 mm	3	SS-1pol-30-10-3



SSH-1pol-45

Bezeichnung	VPE	Artikelnummer
- Sammelschienenhalter 1-polig N/PE, bestehend aus: - 1x Sammelschienenhalter - 2x Befestigungsschraube 4,8x38 - Bauhöhe 45mm	1 20	SSH-1pol-45
- Sammelschienenhalter 1-polig N/PE, bestehend aus: - 1x Sammelschienenhalter - 2x Befestigungsschraube 4,8x38 - Bauhöhe 55mm	1 20	SSH-1pol-55



HS1/2/3-15

Hutprofilschiene 7,5mm hoch für BT 120/140mm / 15mm hoch für BT 210/230mm

Für die Montage der Einbaugeräte werden pro Satz Längsschienen und abhängig von der Felder-Baubreite mehrere Hutprofilschienen benötigt. (Feldbreiten 4 und 5 auf Anfrage)

Bezeichnung	VPE	Artikelnummer
- Hutprofilschiene 1-Feld breit, 7,5mm hoch / 15mm hoch	1 20	HS1-7,5 / HS1-15
- Hutprofilschiene 2-Feld breit, 7,5mm hoch / 15mm hoch	1 10	HS2-7,5 / HS2-15
- Hutprofilschiene 3-Feld breit, 7,5mm hoch / 15mm hoch	1 10	HS3-7,5 / HS3-15



BFS-HS

Befestigungssatz Hutschiene

Für die Montage der Hutschienen an der Längsschiene.

Bezeichnung	VPE	Artikelnummer
- Befestigungssatz, 25x Linsenblechschraube 4,8x9,5	1	BFS-HS



ABS-Z35

Abstandshalter für Hutprofilschienen (Schutzklasse I, geerdet)

Dient zur Befestigung der Hutprofilschienen für Klemmen an den Längsschienen bei Verteilungen SKI.

Bezeichnung	VPE	Artikelnummer
- Abstandshalter-Set Z35, Hutprofilschiene wird 35mm versetzt aufgeschraubt	25	ABS-Z35
- Abstandshalter-Set Z57, Hutprofilschiene wird 57mm versetzt aufgeschraubt	25	ABS-Z57
- Abstandshalter-Set Z96, Hutprofilschiene wird 96mm versetzt aufgeschraubt	25	ABS-Z96



KLIS-S35

Isolierstützen für Hutprofilschienen (Schutzklasse II, schutzisoliert)

Dient zur Befestigung der Hutprofilschienen für Klemmen an den Längsschienen bei Verteilungen SKII.

Bezeichnung	VPE	Artikelnummer
- Isolierstützen-Set	25	KLIS-S
- Isolierstützen-Set 16mm	25	KLIS-S16
- Isolierstützen-Set 35mm	25	KLIS-S35



ADH32

Abdeckungshalter

dient zur Befestigung der Feldabdeckung am Geräteträger bei Hutschiene

Bezeichnung	VPE	Artikelnummer
- Abdeckungshalter bei Hutschiene 7,5mm BT 120/140mm Abdeckung PS	100	ADH27
- Abdeckungshalter bei Hutschiene 15mm BT 210/230mm Abdeckung PS	100	ADH32
- Abdeckungshalter bei Hutschiene 15mm BT 210/230mm Abdeckung PRL	100	ADH63



VD



VDP

Vierteldrehverschluss

Bezeichnung	VPE	Artikelnummer
- Vierteldrehverschluss	100	VD
- Vierteldrehverschluss plombierbar	100	VDP



ADG

Abdeckungsgriff schwarz

Bezeichnung	VPE	Artikelnummer
- Abdeckungsgriff: 1x Griff, 2x Linsenschraube 3,5x9,5	1 100	ADG

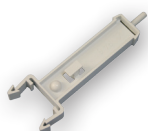

TR3010

Abdeckungshalter für Sammelschienen

Zum Aufrasten auf Cu-Sammelschienen.

- Farbe: RAL 7035 (lichtgrau)
- Material: PA6
- Schraube M6x20 plombierbar

Abstand
zwischen
Kupferschiene
und Abdeckung =
108 mm



Bezeichnung	VPE	Artikelnummer
- Abdeckungshalter für Sammelschiene 30x8mm, ohne Gewinde	50	TR308
- Abdeckungshalter für Sammelschiene 30x10mm, mit Gewinde M6	50	TR3010
- Abdeckungshalter für Sammelschiene 40x10mm, mit Gewinde M6	50	TR4010
- Abdeckungshalter für Sammelschiene 50x10mm, mit Gewinde M6	40	TR5010
- Abdeckungshalter für Sammelschiene 60x10mm, mit Gewinde M6	40	TR6010



Montagebeispiel

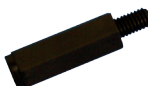

DB30M6

Distanzhalter 30mm

Zur Erhöhung des Abstands zwischen Kupferschiene und Abdeckung um 30mm.

Bezeichnung	VPE	Artikelnummer
- Distanzhalter	1 50	DB30M6



AS12TEgrau



AS1000grau

Abdeckstreifen

Eigenschaften: passend für alle offenen Feldabdeckungen mit dem Schlitzmaß 46x216mm

Bezeichnung	VPE	Artikelnummer
- Abdeckstreifen sperrbar	25 / 100 / 500	2KUN0107
- Abdeckstreifen grau geschlossen, Länge 220mm, Breite 53mm	25 / 100 / 500	AS12TEgrau
- Abdeckstreifen grau offen, Länge 220mm, Breite 53mm	25 / 100 / 500	AS12TEgrauo
- Abdeckstreifen grau geschlossen, Länge 1000mm, Breite 53mm	25 / 100 / 500	AS1000grau
- Abdeckstreifen weiß geschlossen, Länge 220mm, Breite 53mm	25 / 100 / 500	AS12TEweiß
- Abdeckstreifen weiß offen, Länge 220mm, Breite 53mm	25 / 100 / 500	AS12TEweißo



HW01

Hohlwandinbausatz

Zubehörsatz zur Aufrüstung der Unterputzverteiler Bautiefe 120mm zu Hohlwandverteilung.

Bezeichnung	VPE	Artikelnummer
- Hohlwandinbausatz	1	HW01

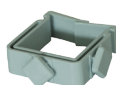

DH33

Drahthalter

33x33mm, zum Einrasten in Hutschiene 0 und 90 Grad, Farbe lichtgrau (RAL 7035)

Bezeichnung	VPE	Artikelnummer
- Drahthalter	100	DH33



PP-12-iso



Montagebeispiel

Patch-Panel

Patch-Panel zur Aufnahme von 12 Kommunikationsmodulen (RJ45,LWL,Koax) inkl. Isolierhalter (Klis) und Beschriftungsstreifen

Bezeichnung	VPE	Artikelnummer
- Patch-Panel für Mediafeld 1 Feld breit	1	PP-12-iso
- Patch-Panel für Mediafeld 2 Feld breit	1	PP-24-iso
- RJ45-Modul für Patch Panel	1	RJ45-PP



SF41



SF44



SF45



NF2

Flansche

Bezeichnung	VPE	Artikelnummer
- Flanschplatte (geschlossen), IP54, Einbauöffnung 83x215 mm BT 230mm	1 15	SF41
- Flanschplatte mit Nippelflansch, IP41, Einbauöffnung 83x215 mm BT 230mm	1 15	SF44
- Moosgummiflansch, IP54, Einbauöffnung 83x215 mm BT 230mm	1 15	SF45
- Nippelflansch, IP41, Einbauöffnung 80x200mm, RAL 9016 BT 210mm	1 20	NF1w
- Nippelflansch, IP41, Einbauöffnung 46x180mm, RAL 9016 BT 140-210mm	1 20	NF2w
- Nippelflansch, IP41, Einbauöffnung 46x180mm, RAL 9016 BT 120mm	1 20	NF3g

Türschloss für Schränke für BT 120-210mm



Bezeichnung	VPE	Artikelnummer
- Schließung universal Zylinderschloss	1	ZVS
- Ersatzschlüssel	1	ZVS-S

Schwenkhebel & Zubehör für BT 230mm



Bezeichnung	VPE	Artikelnummer
- Schwenkhebel für Profilhalbzylinder (PHZ)	1	SH
- Schwenkhebel für PHZ, mit Stangenschloss (StS) inkl. Verschlusszunge	1	SHP
- Profilhalbzylinder EK333 inkl. Schlüssel	1	PHZ1-EK333
- Ersatzschlüssel EK333	1	PHZ1-EK333-S
- Profilhalbzylinder 110319N inkl. Schlüssel	1	PHZ2-110319N
- Ersatzschlüssel 110319N	1	PHZ2-110319N-S
- Profilhalbzylinder Doppelbart 5mm	1	PHZ1-DB5
- Schlüssel Doppelbart 5mm	1	PHZ1-DB5-S
- Profilhalbzylinder vierkant 8	1	PHZ1-4K
- Schlüssel vierkant 8	1	PHZ1-4K-S

Schottwand für BT 120/140mm (A) / BT 210/230mm

Bezeichnung	VPE	Artikelnummer
- Schottwand 4-reihig, BT 120/140mm (A) / BT 210/230mm	1	SW4A / SW4
- Schottwand 5-reihig, BT 120/140mm (A) / BT 210/230mm	1	SW5A / SW5
- Schottwand 6-reihig, BT 120/140mm (A) / BT 210/230mm	1	SW6A / SW6
- Schottwand 7-reihig, BT 120/140mm (A) / BT 210/230mm	1	SW7A / SW7
- Schottwand 8-reihig, BT 210/230mm	1	SW8
- Schottwand 9-reihig, BT 210/230mm	1	SW9

Sonstiges

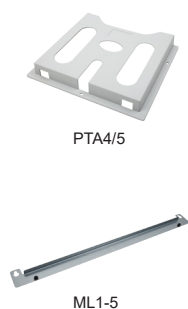

Bezeichnung	VPE	Artikelnummer
- Plantasche DIN A4, selbstklebend	20	PTA4
- Plantasche DIN A5, selbstklebend	20	PTA5
- Zusätzliche N-PE Schiene für Verteilerfeld	1	N-PE
- Schnellbefestigungshalter für Gehäuse an Wand, 1-feld breit für BT 210mm	1	ML1
- Schnellbefestigungshalter für Gehäuse an Wand, 2-feld breit für BT 210mm	1	ML2
- Schnellbefestigungshalter für Gehäuse an Wand, 3-feld breit für BT 210mm	1	ML3
- Schnellbefestigungshalter für Gehäuse an Wand, 4-feld breit für BT 210mm	1	ML4
- Schnellbefestigungshalter für Gehäuse an Wand, 5-feld breit für BT 210mm	1	ML5

Notizen:

Bei Fragen stehen wir jederzeit gerne zur Verfügung. Sie finden uns unter:

Alphatec Schaltschranksysteme GmbH
Bibersbach 2a
93179 Brennberg

Tel.: +49 (0)9484 951090
Fax: +49 (0)9484 951095

www.alphatec-systeme.de
info@alphatec-systeme.de





www.alphatec-systeme.de

Alphatec Schaltschranksysteme GmbH, Bibersbach 2a, 93179 Brennbach, Deutschland
Tel.: +49 (0)9484 951090 Fax: +49 (0)9484 951095
info@alphatec-systeme.de